

Moulinex®

UNO

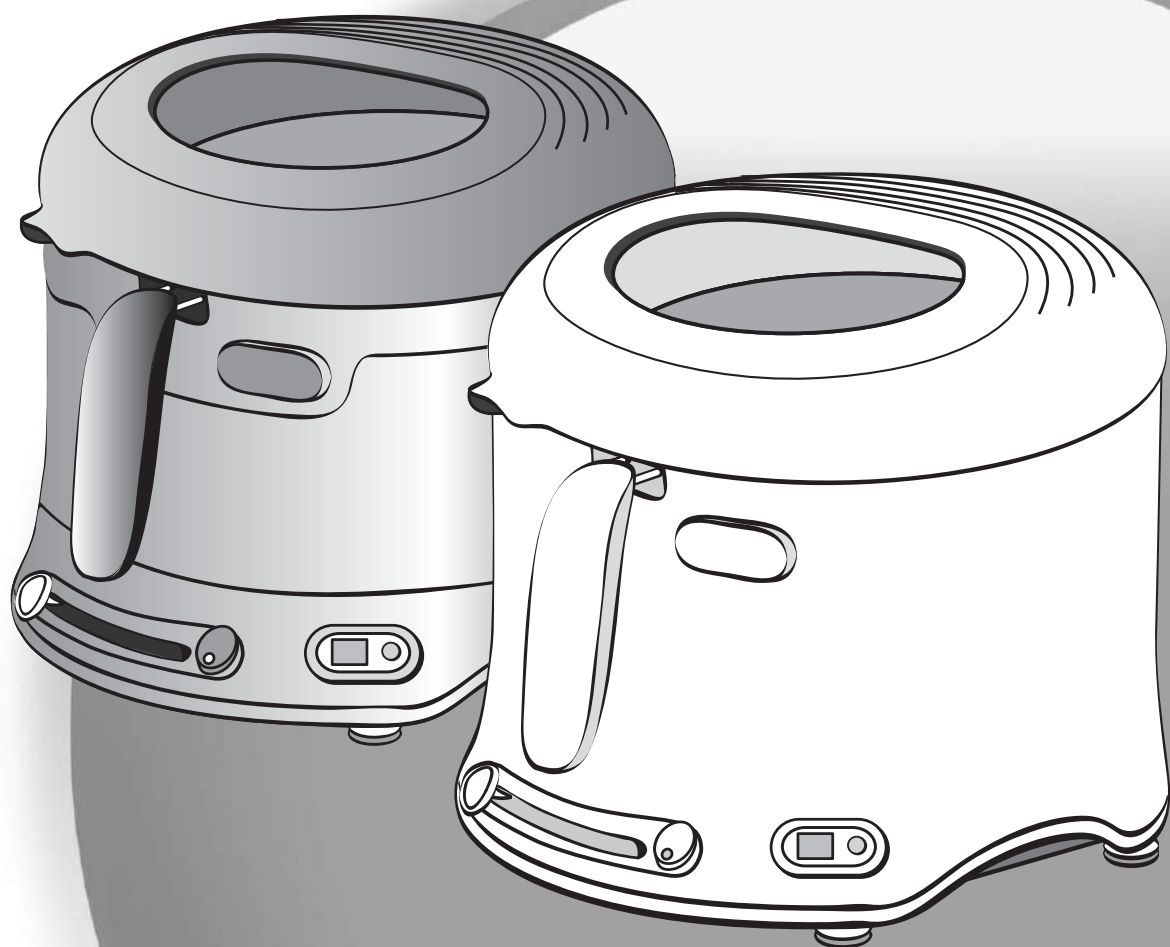

www.moulinex.com

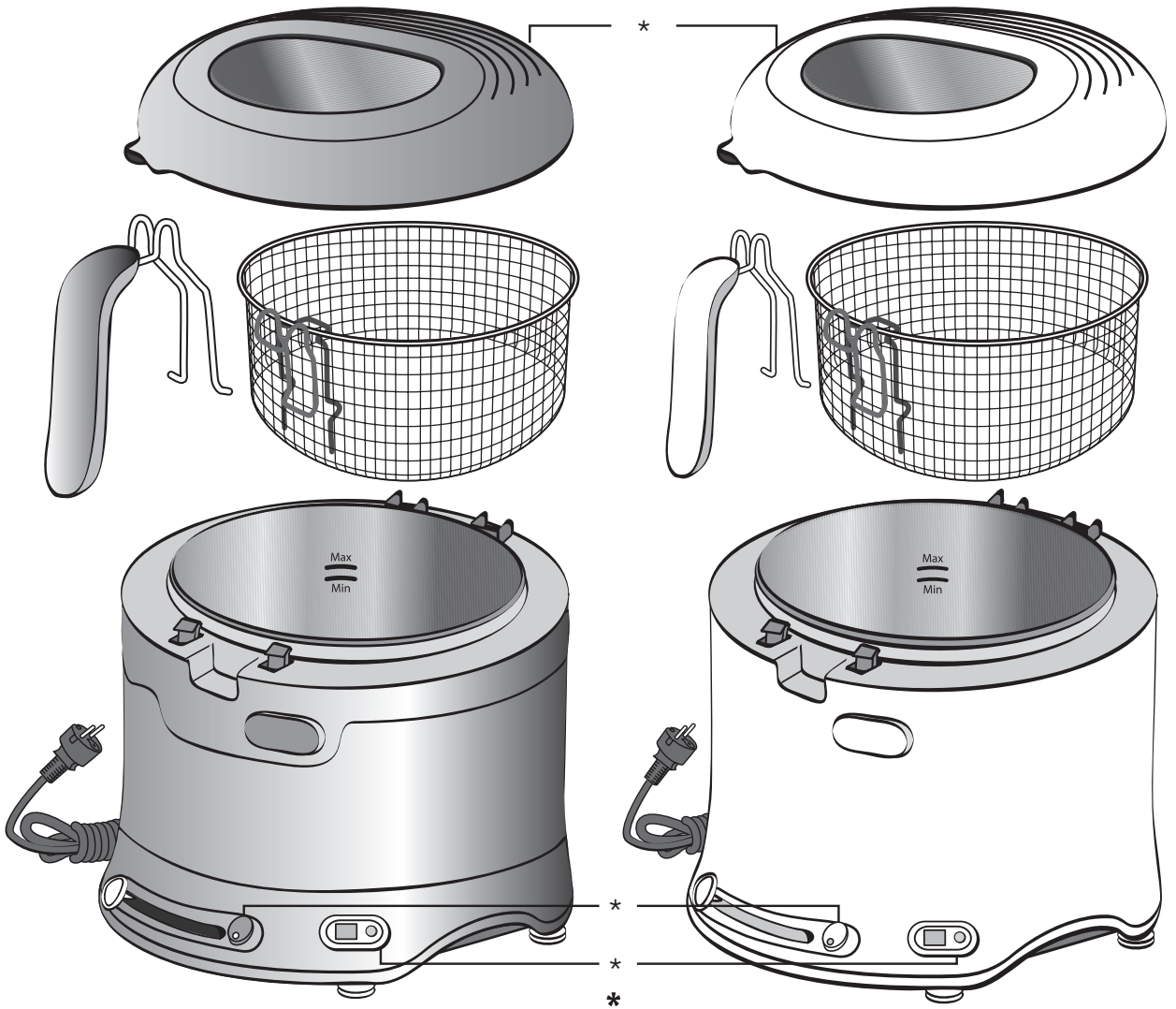

*selon modèle • depending on model • je nach Modell • a seconda del modello • según modelo • consoante os modelos • Ανάλογα με το μοντέλο • В зависимости от модели • Залежно від моделі • zależnie od modelu • az egyes modellek szerint • podle modelů • podľa modelov • В зависимости от модели • În funcție de model • modellere göre • Зависно од модела • zavisno od modela • Ölede na model • بر حسب مدل • حسب الموديل

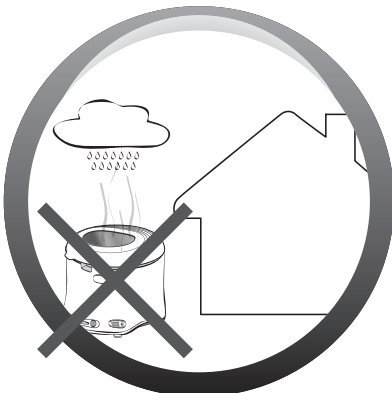

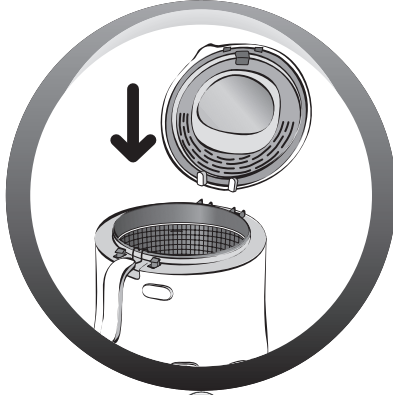
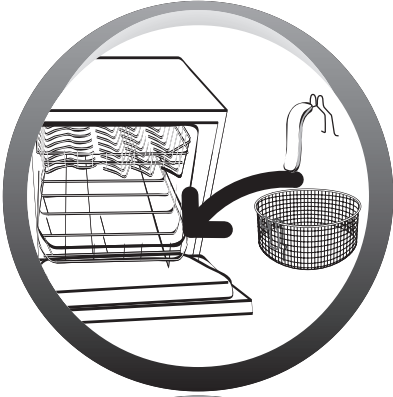
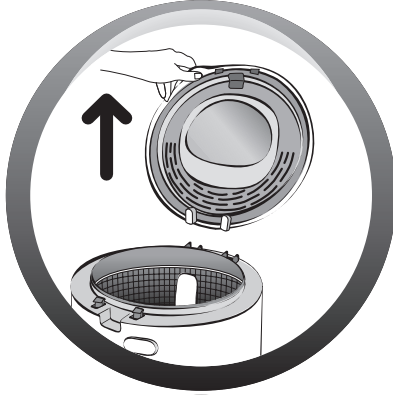



Min 1,6 L
Max 1,8 L

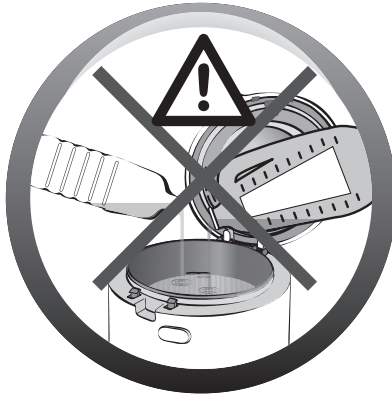
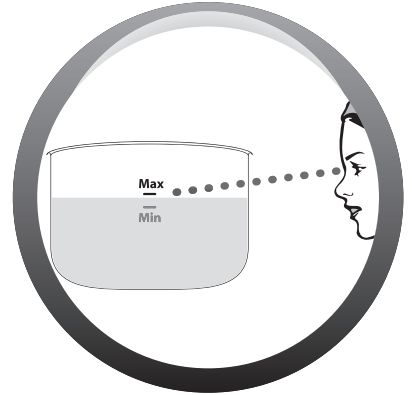

Min 1400 g
Max 1600 g

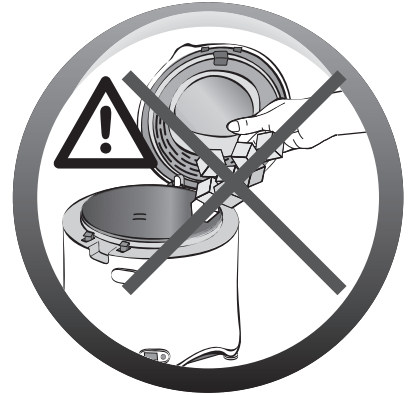
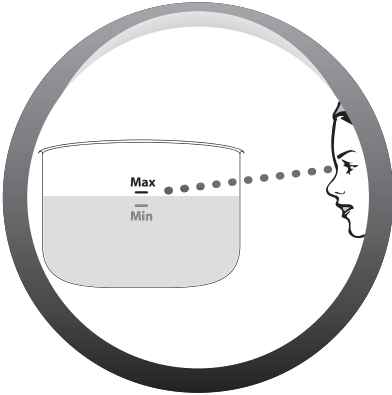



Max 800 g
500 g

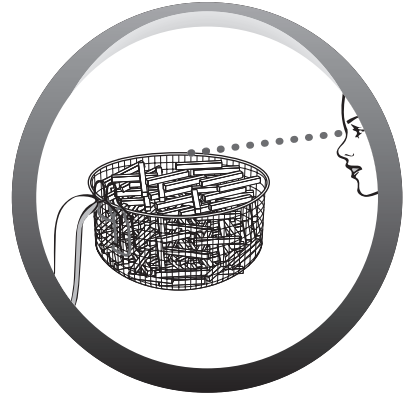
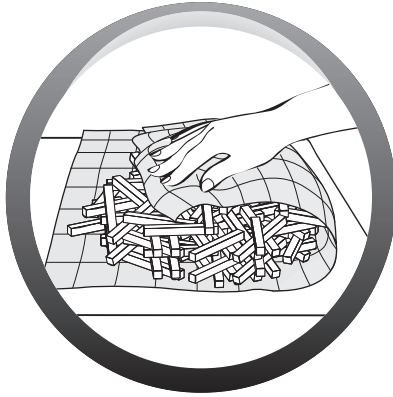

Max 750 g
380 g

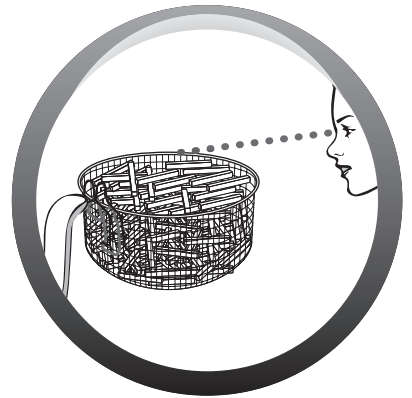
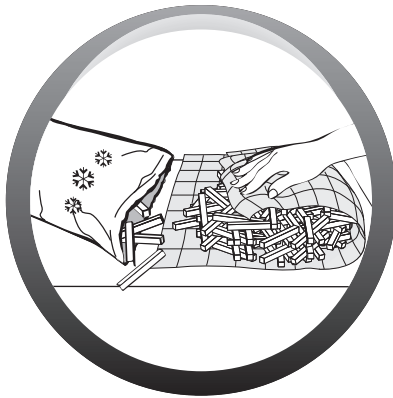

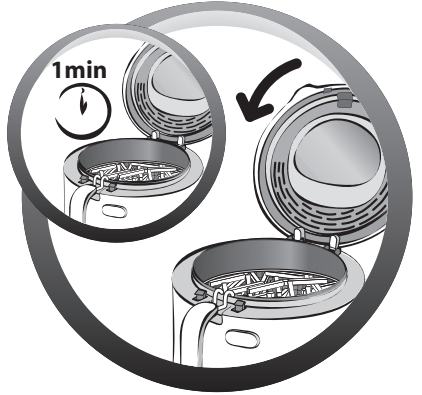
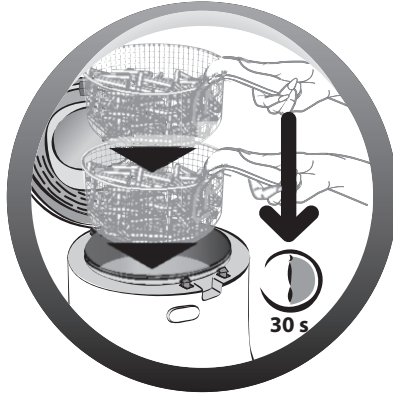
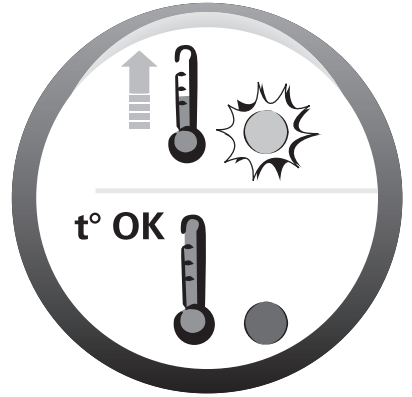
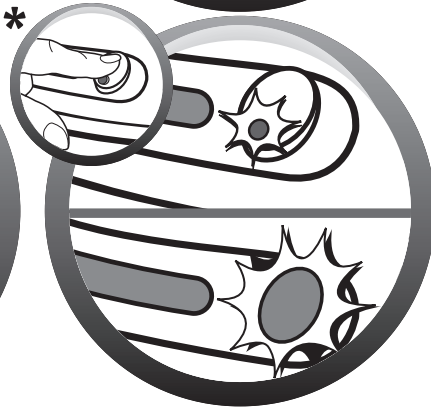

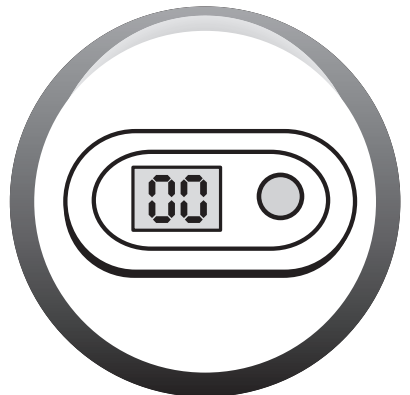
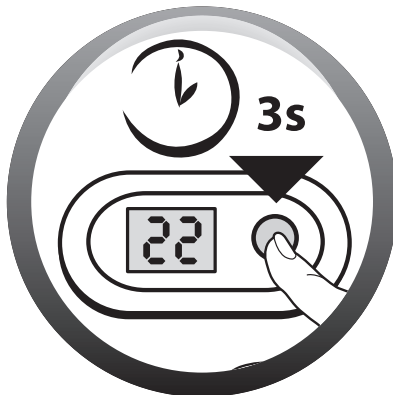
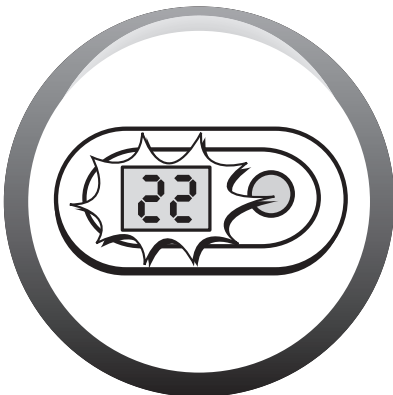
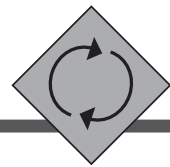
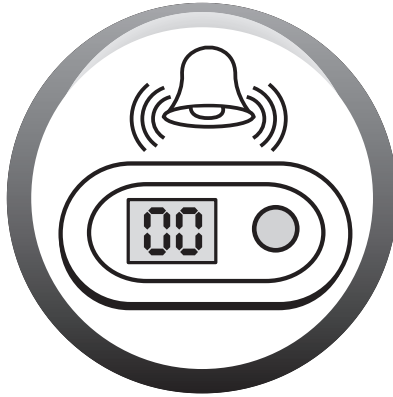
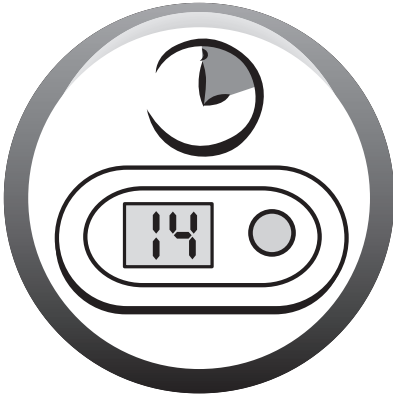
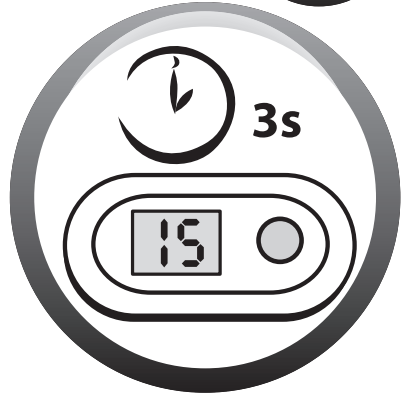
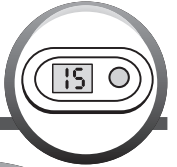

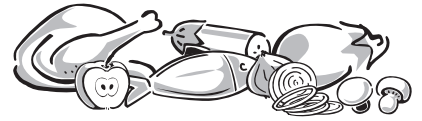

	Nb			
		800 g	170°C	13-16 min.
		500 g	170°C	11-13 min.
		3-4	180°C	15-20 min.
		2	160°C	6-8 min.
		8	150°C	6-8 min.
		10-12	180°C	6-7 min.
		500 g	180°C	4-5 min.
		4	170°C	7-8 min.
* * *	Nb			
		750 g	170°C	13-15 min.
		380 g	170°C	7-8 min.
		3-4	190°C	18-20 min.
		2	190°C	6-8 min.
		22 g	190°C	4-5 min.
		1 Kg	190°C	8-9 min.
		5	190°C	4-5 min.

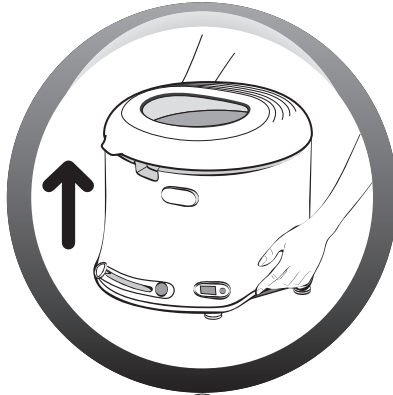
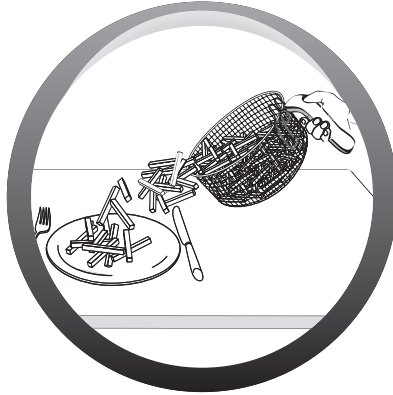
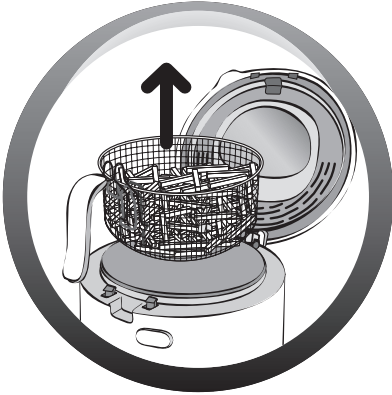
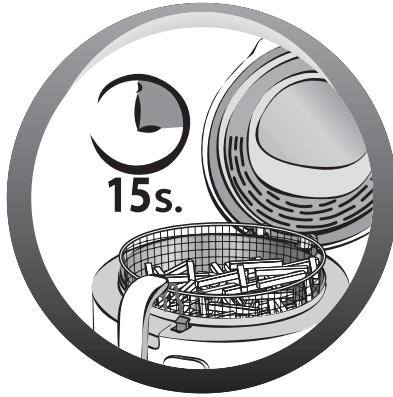
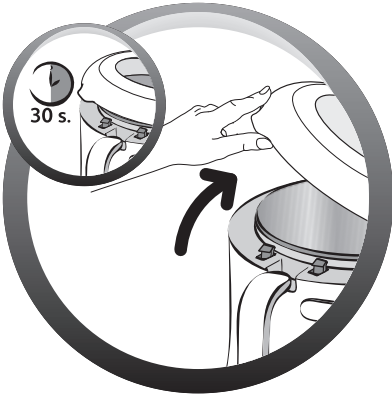
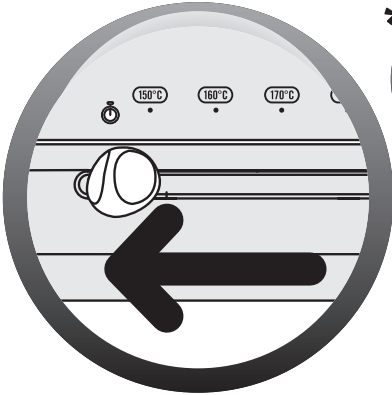

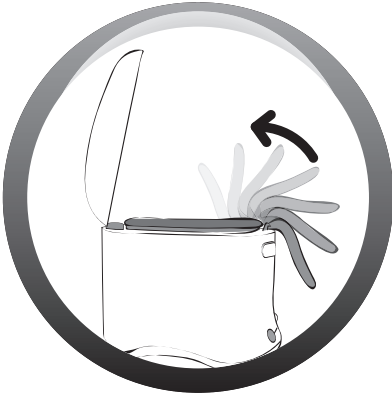
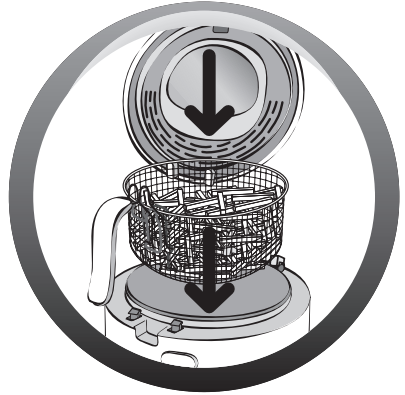
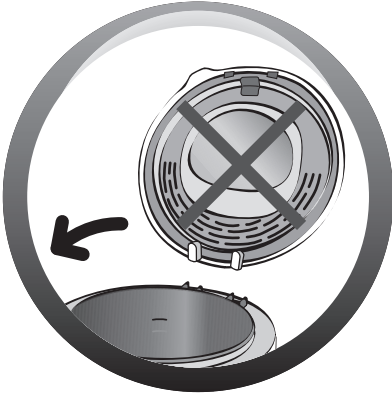
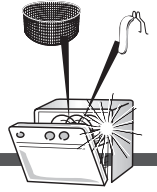



Moulinex®
uno

Ref. NC00113640

www.moulinex.com